



**SWISS+TOOLS<sup>®</sup>**



*S w i s s*  
**M I C R O**

*Schnellwechselsystem*  
*Quick change system*  
*Changement rapide*

**SCHAUBLIN**

# Aussenbearbeitung external machining Usinage externe

## Vorteile

- Hochgenaue Positionierung des Wechselkopfes
- Passgenaue, steife Schnittstelle mit Kegel/Plananlage
- hohe Wiederholgenauigkeit
- Spitzenhöhe ist gewährleistet
- Innenkühlung ist Standard
- Ausserhalb der Maschine voreinstellbar
- Einfaches Handling (nur eine Klemmschraube)

## Advantages

- Highly accurate positioning of the replaceable head
- Precisely fitting, rigid interface with cone/face contact
- high repeatability
- Center height is guaranteed
- Internal cooling is standard
- Presettable outside the machine
- Easy handling (only one clamping screw)

## Advantages

- Positionnement extrêmement précis de la tête interchangeable
- Interface rigide et parfaitement ajustée avec cône/système plat
- répétabilité élevée
- La hauteur de centre est garantie
- Le refroidissement interne est standard
- Pré-réglable en dehors de la machine
- Manipulation facile (une seule vis de serrage)

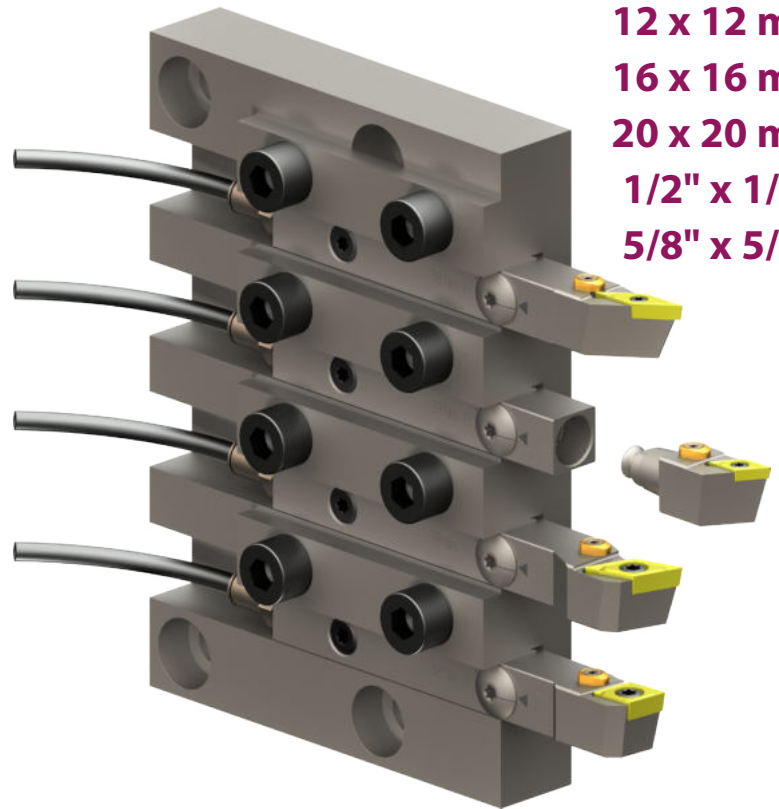

12 x 12 mm  
16 x 16 mm  
20 x 20 mm  
1/2" x 1/2"  
5/8" x 5/8"

**Schnellwechselsystem:** Der Vierkantschaft kann in der Maschine gespannt bleiben. Es wird nur das Bearbeitungswerkzeug / Wechselkopf ersetzt. Eine **Voreinstellung** ist ausserhalb der Maschine möglich.

**Quick change**, without having to remove the tool-holder from the gang. **Presetting** is possible outside of the machine.

**Changement rapide** sans avoir besoin de sortir le porte-outil du peigne. **Préréglage** possible en dehors de la machine.

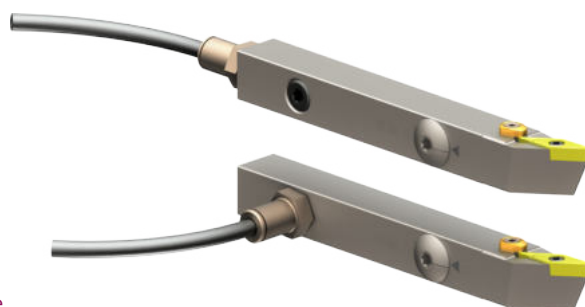

Hochdruckkühlung Innenkühlung  
High pressure inner coolant  
Porte-outils avec arrosage par le centre

# Innenbearbeitung

## Internal machining

### Usinage interne

#### Vorteile

- Hochgenaue Positionierung des Wechselkopfes
- Passgenaue, steife Schnittstelle mit Kegel/Plananlage
- hohe Wiederholgenauigkeit
- Spitzenhöhe ist gewährleistet
- Innenkühlung ist Standard
- Ausserhalb der Maschine voreinstellbar
- Einfaches Handling (nur eine Klemmschraube)

#### Advantages

- Highly accurate positioning of the replaceable head
- Precisely fitting, rigid interface with cone/face contact
- high repeatability
- Center height is guaranteed
- Internal cooling is standard
- Presettable outside the machine
- Easy handling (only one clamping screw)

#### Advantages

- Positionnement extrêmement précis de la tête interchangeable
- Interface rigide et parfaitement ajustée avec cône/système plat
- répétabilité élevée
- La hauteur de centre est garantie
- Le refroidissement interne est standard
- Pré-réglable en dehors de la machine
- Manipulation facile (une seule vis de serrage)



**Schnellwechselsystem:** Der Rundschaft kann in der Maschine gespannt bleiben. Es wird nur das Bearbeitungswerkzeug / Wechselkopf ersetzt. Eine **Voreinstellung** ist ausserhalb der Maschine möglich.

**Quick change**, without having to remove the tool-holder from the gang. **Presetting** is possible outside of the machine.

**Changement rapide** sans avoir besoin de sortir le porte-outil du peigne. **Pré-réglage** possible en dehors de la machine.

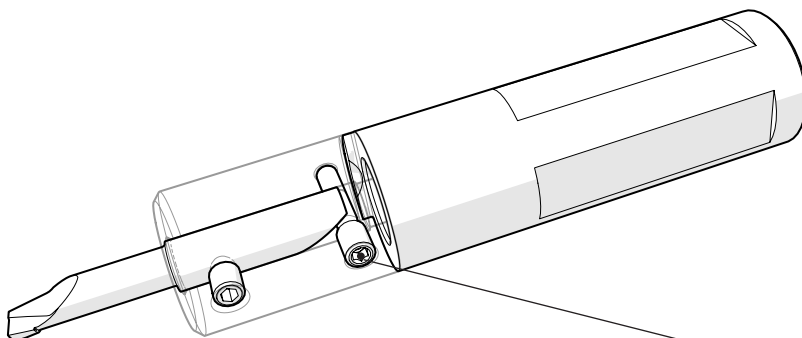

Schneideinsatz wird durch den Stift auf **Spitzenhöhe** ausgerichtet

The pin is guaranteed the correct position of the cutting edge **high**.

La goupille place le tranchant au **centre haut**.



Grundhalter vierkant

Square holders

Support de base

	1	2	3	4
V12.LW3.K01.080	<b>V12</b>	<b>LW3</b>	<b>K01</b>	<b>080</b>

<b>1</b>	Schaftgrösse Shank size Dimensions de burin	V12 V13 V15 V16 V20	12 x 12 mm 1/2 x 1/2 " 5/8 x 5/8 " 16 x 16 mm 20 x 20 mm
<b>2</b>	Schnittstelle Interface Interface	LW3 LW4 LW5	12 x 12 mm 1/2 x 1/2 " 16 x 16 mm 5/8 x 5/8 " 20 x 20 mm
<b>3</b>	Kühlmittel Coolant Arrosage	K01	Innere Kühlmittelduchführung Inner coolant supply Avec arrosage interne
<b>4</b>	Schaftlänge Shank length Longueur de tige	080	80 mm

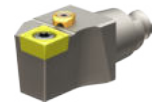

Schneidkopf

Cutting head



Tête de coupe

	1	2	3	4
LW3.SCLCR.0620.09	<b>LW3</b>	<b>SCLCR</b>	<b>0620</b>	<b>09</b>

<b>1</b>	Schnittstelle Interface Interface	LW3 LW4 LW5	12 x 12 mm 1/2 x 1/2 " 16 x 16 mm 5/8 x 5/8 " 20 x 20 mm
<b>2</b>	ISO Bezeichnung ISO Code ISO Code	SCLCR	WP-Typ, Spannung, Einbaulage Insert typ, clamping, orientation
<b>3</b>	Abmessung Dimension Dimension	06 20	f - Mass / Länge L - dimension / length
<b>4</b>	Schneidenlänge Cutting length longueur de coupe	09	Wendeplattengösse Insert size Plaquette taille

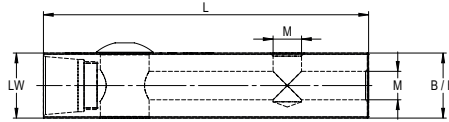



Bestell-Nr. / Order number/ Code	SG	b/h	L	LW	Coolant M	kg		
V12.LW3.K01.080	12	12 / 12	80	3	M8x1	0.06	LWX.ER1.008.004	LW3.ER1.012.014
V13.LW3.K01.080	1/2"	12 / 12.7	80	3	M8x1	0.07	LWX.ER1.008.004	LW3.ER1.012.014
V15.LW4.K01.080	5/8"	16 / 15.875	80	4	M8x1	0.12	LWX.ER1.008.004	LW4.ER1.014.019
V16.LW4.K01.080	16	16 / 16	80	4	M8x1	0.13	LWX.ER1.008.004	LW4.ER1.014.019
V20.LW5.K01.100	20	20 / 20	100	5	M8x1	0.27	LWX.ER1.008.004	LW5.ER1.015.023

- für effiziente Drehbearbeitung
- mit Kühlmitteldirektanschluss
- Sonderabmasse auf Anfrage





- to turn efficiently
- with direct coolant connection
- Special dimensions on request

- pour un tournage efficace
- avec raccord direct de liquide de refroidissement
- Dimensions spéciales sur demande

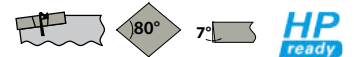
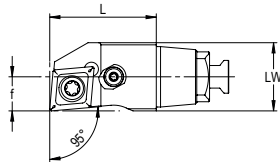
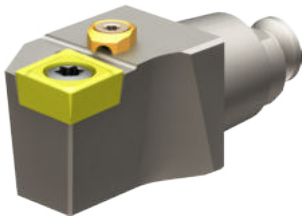
SCLC R/L

95°/80°



Bestell.Nr. / Order number/ Code	LW	f	L	Wendeplatte/ Insert/ Plaquette	kg				
LW3.SCLCR.0620.06	3	6	20	ISO - CC . . 06 02 . . ANSI - CC . . 21.5 . .	0.03	WCA.ER1.001.000	WCA.ER2.001.006 (0.9 Nm)	LWX.ER1.007.002	LW3.U00.ER1.000
LW3.SCLCL.0620.06	3	6	20	ISO - CC . . 06 02 . . ANSI - CC . . 21.5 . .	0.03	WCA.ER1.001.000	WCA.ER2.001.006 (0.9 Nm)	LWX.ER1.007.002	LW3.U00.ER1.000
LW3.SCLCR.0620.09	3	6	20	ISO - CC . . 09 T3 . . ANSI - CC . . 32.5 . .	0.03	WCB.ER1.001.000	WCB.ER2.001.009 (3.0 Nm)	LWX.ER1.007.002	LW3.U00.ER1.000
LW3.SCLCL.0620.09	3	6	20	ISO - CC . . 09 T3 . . ANSI - CC . . 32.5 . .	0.03	WCB.ER1.001.000	WCB.ER2.001.009 (3.0 Nm)	LWX.ER1.007.002	LW3.U00.ER1.000
LW4.SCLCR.0825.06	4	8	25	ISO - CC . . 09 T3 . . ANSI - CC . . 32.5 . .	0.04	WCA.ER1.001.000	WCA.ER2.001.006 (0.9 Nm)	LWX.ER1.007.002	LW4.U00.ER1.000
LW4.SCLCL.0825.06	4	8	25	ISO - CC . . 09 T3 . . ANSI - CC . . 32.5 . .	0.04	WCA.ER1.001.000	WCA.ER2.001.006 (0.9 Nm)	LWX.ER1.007.002	LW4.U00.ER1.000
LW4.SCLCR.0825.09	4	8	25	ISO - CC . . 09 T3 . . ANSI - CC . . 32.5 . .	0.04	WCB.ER1.001.000	WCB.ER2.001.009 (3.0 Nm)	LWX.ER1.007.002	LW4.U00.ER1.000
LW4.SCLCL.0825.09	4	8	25	ISO - CC . . 09 T3 . . ANSI - CC . . 32.5 . .	0.04	WCB.ER1.001.000	WCB.ER2.001.009 (3.0 Nm)	LWX.ER1.007.002	LW4.U00.ER1.000
LW5.SCLCR.1025.09	5	10	25	ISO - CC . . 09 T3 . . ANSI - CC . . 32.5 . .		WCB.ER1.001.000	WCB.ER2.001.009 (3.0 Nm)	LWX.ER1.007.002	LW4.U00.ER1.000
LW5.SCLCL.1025.09	5	10	25	ISO - CC . . 09 T3 . . ANSI - CC . . 32.5 . .		WCB.ER1.001.000	WCB.ER2.001.009 (3.0 Nm)	LWX.ER1.007.002	LW4.U00.ER1.000

SCMC N 50°/80°/50°

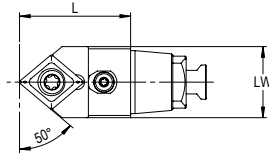
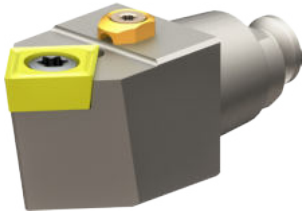

Bestell.Nr. / Order number/ Code	LW	f	L	Wendeplatte/ Insert/ Plaquette	kg				
LW3.SCMCN.0020.06	3	0	20	ISO - CC . . 06 02 . . ANSI - CC . . 21.5 . .	0.03	WCA.ER1.001.000	WCA.ER2.001.006 (0.9 Nm)	LWX.ER1.007.002	LW3.U00.ER1.000
LW3.SCMCN.0020.09	3	0	20	ISO - CC . . 09 T3 . . ANSI - CC . . 32.5 . .	0.03	WCB.ER1.001.000	WCB.ER2.001.009 (3.0 Nm)	LWX.ER1.007.002	LW3.U00.ER1.000
LW4.SCMCN.0025.06	4	0	25	ISO - CC . . 06 02 . . ANSI - CC . . 21.5 . .	0.04	WCA.ER1.001.000	WCA.ER2.001.006 (0.9 Nm)	LWX.ER1.007.002	LW4.U00.ER1.000
LW4.SCMCN.0025.09	4	0	25	ISO - CC . . 09 T3 . . ANSI - CC . . 32.5 . .	0.04	WCB.ER1.001.000	WCB.ER2.001.009 (3.0 Nm)	LWX.ER1.007.002	LW4.U00.ER1.000
LW5.SCMCN.0025.09	5	0	25	ISO - CC . . 09 T3 . . ANSI - CC . . 32.5 . .	0.06	WCB.ER1.001.000	WCB.ER2.001.009 (3.0 Nm)	LWX.ER1.007.002	LW4.U00.ER1.000

PCLN R/L 95°/80°

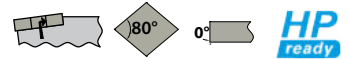
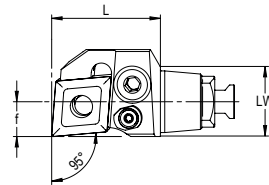
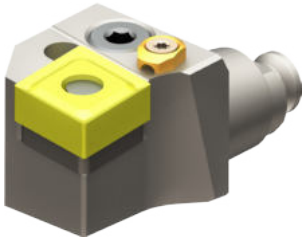

Bestell.Nr. / Order number/ Code	LW	f	L	Wendeplatte/ Insert/ Plaquette	kg					
LW4.PCLNR.0825.12	4	8	25	ISO - CN . . 12 04 . . ANSI - CN . . 43 . .	0.04	WCD.ER2.101.003	WCD.ER4.101.017 (5.0 Nm)	WCD.ER3.101.000	WCD.ER1.101.000	LWX.ER1.007.002
LW4.PCLNL.0825.12	4	8	25	ISO - CN . . 12 04 . . ANSI - CN . . 43 . .	0.04	WCE.ER2.101.004	WCE.ER4.101.004 (5.0 Nm)	WCE.ER3.101.000	WCE.ER1.101.000	LWX.ER1.007.002
LW5.PCLNR.1030.12	5	10	30	ISO - CN . . 12 04 . . ANSI - CN . . 43 . .	0.1	WCD.ER2.101.003	WCD.ER4.101.017 (5.0 Nm)	WCD.ER3.101.000	WCD.ER1.101.000	LWX.ER1.007.002
LW5.PCLNL.1030.12	5	10	30	ISO - CN . . 12 04 . . ANSI - CN . . 43 . .	0.1	WCE.ER2.101.004	WCE.ER4.101.004 (5.0 Nm)	WCE.ER3.101.000	WCE.ER1.101.000	LWX.ER1.007.002



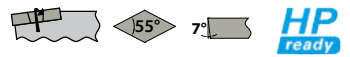
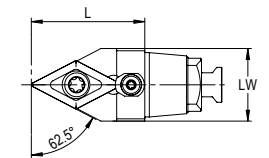
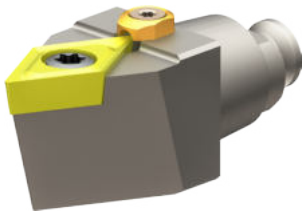

SDNC N 50°/80°/50°

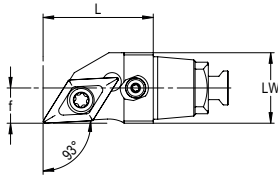

Bestell.Nr. / Order number/ Code	LW	f	L	Wendeplatte/ Insert/ Plaquette	kg				
LW3.SDNCN.0020.07	3	0	20	ISO - DC . . 07 02 . . ANSI - DC . . 21.5 . .	0.03	WCA.ER1.001.000	WCA.ER2.001.006 (0.9 Nm)	LWX.ER1.007.002	LW3.U00.ER1.000
LW3.SDNCN.0025.11	3	0	25	ISO - DC . . 11 T3 . . ANSI - DC . . 32.5 . .	0.03	WCB.ER1.001.000	WCB.ER2.001.009 (3.0 Nm)	LWX.ER1.007.002	LW3.U00.ER1.000
LW4.SDNCN.0025.07	4	0	25	ISO - DC . . 07 02 . . ANSI - DC . . 21.5 . .	0.04	WCA.ER1.001.000	WCA.ER2.001.006 (0.9 Nm)	LWX.ER1.007.002	LW4.U00.ER1.000
LW4.SDNCN.0025.11	4	0	25	ISO - DC . . 11 T3 . . ANSI - DC . . 32.5 . .	0.04	WCB.ER1.001.000	WCB.ER2.001.009 (3.0 Nm)	LWX.ER1.007.002	LW4.U00.ER1.000
LW5.SDNCN.0030.07	5	0	30	ISO - DC . . 07 02 . . ANSI - DC . . 21.5 . .	0.07	WCA.ER1.001.000	WCA.ER2.001.006 (0.9 Nm)	LWX.ER1.007.002	LW4.U00.ER1.000
LW5.SDNCN.0030.11	5	0	30	ISO - DC . . 11 T3 . . ANSI - DC . . 32.5 . .	0.07	WCB.ER1.001.000	WCB.ER2.001.009 (3.0 Nm)	LWX.ER1.007.002	LW4.U00.ER1.000





SDJC R/L 93°/55°

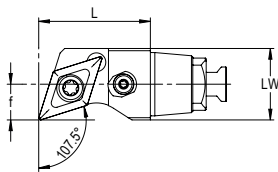
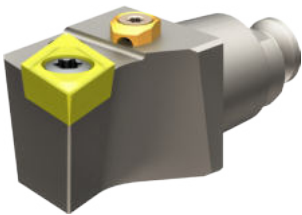

Bestell.Nr. / Order number/ Code	LW	f	L	Wendeplatte/ Insert/ Plaquette	kg				
LW3.SDJCR.0620.07	3	6	20	ISO - DC . . 07 02 . . ANSI - DC . . 21.5 . .	0.03	WCA.ER1.001.000	WCA.ER2.001.006 (0.9 Nm)	LWX.ER1.007.002	LW3.U00.ER1.000
LW3.SDJCL.0620.07	3	6	20	ISO - DC . . 07 02 . . ANSI - DC . . 21.5 . .	0.03	WCA.ER1.001.000	WCA.ER2.001.006 (0.9 Nm)	LWX.ER1.007.002	LW3.U00.ER1.000
LW3.SDJCR.0625.11	3	6	25	ISO - DC . . 11 T3 . . ANSI - DC . . 32.5 . .	0.03	WCB.ER1.001.000	WCB.ER2.001.009 (3.0 Nm)	LWX.ER1.007.002	LW3.U00.ER1.000
LW3.SDJCL.0625.11	3	6	25	ISO - DC . . 11 T3 . . ANSI - DC . . 32.5 . .	0.03	WCB.ER1.001.000	WCB.ER2.001.009 (3.0 Nm)	LWX.ER1.007.002	LW3.U00.ER1.000
LW4.SDJCR.0825.07	4	8	25	ISO - DC . . 07 02 . . ANSI - DC . . 21.5 . .	0.04	WCA.ER1.001.000	WCA.ER2.001.006 (0.9 Nm)	LWX.ER1.007.002	LW4.U00.ER1.000
LW4.SDJCL.0825.07	4	8	25	ISO - DC . . 07 02 . . ANSI - DC . . 21.5 . .	0.04	WCA.ER1.001.000	WCA.ER2.001.006 (0.9 Nm)	LWX.ER1.007.002	LW4.U00.ER1.000
LW4.SDJCR.0825.11	4	8	25	ISO - DC . . 11 T3 . . ANSI - DC . . 32.5 . .	0.04	WCB.ER1.001.000	WCB.ER2.001.009 (3.0 Nm)	LWX.ER1.007.002	LW4.U00.ER1.000
LW4.SDJCL.0825.11	4	8	25	ISO - DC . . 11 T3 . . ANSI - DC . . 32.5 . .	0.04	WCB.ER1.001.000	WCB.ER2.001.009 (3.0 Nm)	LWX.ER1.007.002	LW4.U00.ER1.000
LW5.SDJCR.1025.11	5	10	25	ISO - DC . . 11 T3 . . ANSI - DC . . 32.5 . .	0.06	WCB.ER1.001.000	WCB.ER2.001.009 (3.0 Nm)	LWX.ER1.007.002	LW4.U00.ER1.000
LW5.SDJCL.1025.11	5	10	25	ISO - DC . . 11 T3 . . ANSI - DC . . 32.5 . .	0.06	WCB.ER1.001.000	WCB.ER2.001.009 (3.0 Nm)	LWX.ER1.007.002	LW4.U00.ER1.000

SDHC R/L 107.5°/55°



Bestell.Nr. / Order number/ Code	LW	f	L	Wendeplatte/ Insert/ Plaquette	kg				
LW3.SDHCR.0620.07	3	6	20	ISO - DC . . 07 02 . . ANSI - DC . . 21.5 . .	0.03	WCA.ER1.001.000	WCA.ER2.001.006 (0.9 Nm)	LWX.ER1.007.002	LW3.U00.ER1.000
LW3.SDHCL.0620.07	3	6	20	ISO - DC . . 07 02 . . ANSI - DC . . 21.5 . .	0.03	WCA.ER1.001.000	WCA.ER2.001.006 (0.9 Nm)	LWX.ER1.007.002	LW3.U00.ER1.000
LW3.SDHCR.0625.11	3	6	25	ISO - DC . . 11 T3 . . ANSI - DC . . 32.5 . .	0.03	WCB.ER1.001.000	WCB.ER2.001.009 (3.0 Nm)	LWX.ER1.007.002	LW3.U00.ER1.000
LW3.SDHCL.0625.11	3	6	25	ISO - DC . . 11 T3 . . ANSI - DC . . 32.5 . .	0.03	WCB.ER1.001.000	WCB.ER2.001.009 (3.0 Nm)	LWX.ER1.007.002	LW3.U00.ER1.000
LW4.SDHCR.0825.07	4	8	25	ISO - DC . . 07 02 . . ANSI - DC . . 21.5 . .	0.04	WCA.ER1.001.000	WCA.ER2.001.006 (0.9 Nm)	LWX.ER1.007.002	LW4.U00.ER1.000
LW4.SDHCL.0825.07	4	8	25	ISO - DC . . 07 02 . . ANSI - DC . . 21.5 . .	0.04	WCA.ER1.001.000	WCA.ER2.001.006 (0.9 Nm)	LWX.ER1.007.002	LW4.U00.ER1.000
LW4.SDHCR.0825.11	4	8	25	ISO - DC . . 11 T3 . . ANSI - DC . . 32.5 . .	0.04	WCB.ER1.001.000	WCB.ER2.001.009 (3.0 Nm)	LWX.ER1.007.002	LW4.U00.ER1.000
LW4.SDHCL.0825.11	4	8	25	ISO - DC . . 11 T3 . . ANSI - DC . . 32.5 . .	0.04	WCB.ER1.001.000	WCB.ER2.001.009 (3.0 Nm)	LWX.ER1.007.002	LW4.U00.ER1.000
LW5.SDHCR.1025.11	5	10	25	ISO - DC . . 11 T3 . . ANSI - DC . . 32.5 . .	0.07	WCB.ER1.001.000	WCB.ER2.001.009 (3.0 Nm)	LWX.ER1.007.002	LW4.U00.ER1.000
LW5.SDHCL.1025.11	5	10	25	ISO - DC . . 11 T3 . . ANSI - DC . . 32.5 . .	0.07	WCB.ER1.001.000	WCB.ER2.001.009 (3.0 Nm)	LWX.ER1.007.002	LW4.U00.ER1.000

**PDJN R/L 93°/55°**

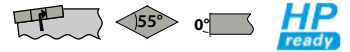
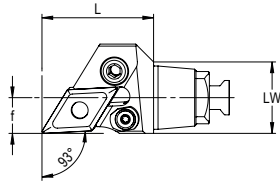
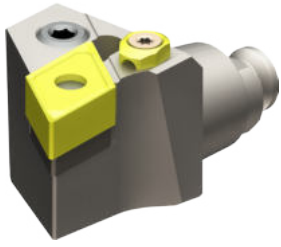

Bestell.Nr. / Order number/ Code	LW	f	L	Wendeplatte/ Insert/ Plaquette	kg					
LW4.PDJNR.0825.11	4	8	25	ISO - DN . . 11 04 . . ANSI - DN . . 33 . .	0.04	WDE.ER2.101.003	WDE.ER4.101.017	WDE.ER3.101.000	WDE.ER1.101.000	LWX.ER1.007.002
LW4.PDJNL.0825.11	4	8	25	ISO - DN . . 11 04 . . ANSI - DN . . 33 . .	0.04	WDE.ER2.101.003	WDE.ER4.101.017	WDE.ER3.101.000	WDE.ER1.101.000	LWX.ER1.007.002
LW5.PDJNR.1025.11	5	10	25	ISO - DN . . 11 04 . . ANSI - DN . . 33 . .	0.06	WDE.ER2.101.003	WDE.ER4.101.017	WDE.ER3.101.000	WDE.ER1.101.000	LWX.ER1.007.002
LW5.PDJNL.1025.11	5	10	25	ISO - DN . . 11 04 . . ANSI - DN . . 33 . .	0.06	WDE.ER2.101.003	WDE.ER4.101.017	WDE.ER3.101.000	WDE.ER1.101.000	LWX.ER1.007.002

**PDNN N 62.5°/55°**

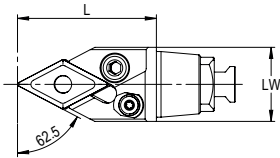
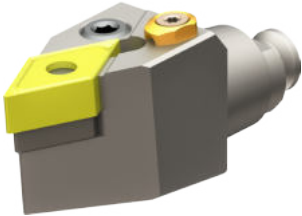

Bestell.Nr. / Order number/ Code	LW	f	L	Wendeplatte/ Insert/ Plaquette	kg					
LW4.PDNNN.0030.11	4	0	30	ISO - DN . . 11 04 . . ANSI - DN . . 33 . .	0.05	WDE.ER2.101.003	WDE.ER4.101.017	WDE.ER3.101.000	WDE.ER1.101.000	LWX.ER1.007.002
LW5.PDNNN.0030.11	5	0	30	ISO - DN . . 11 04 . . ANSI - DN . . 33 . .	0.07	WDE.ER2.101.003	WDE.ER4.101.017	WDE.ER3.101.000	WDE.ER1.101.000	LWX.ER1.007.002

**PWLN R/L 95°/80°**

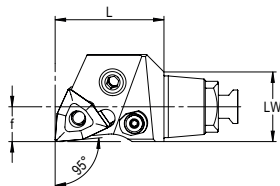

Bestell.Nr. / Order number/ Code	LW	f	L	Wendeplatte/ Insert/ Plaquette	kg					
LW4.PWLN R.0825.06	4	8	25	ISO - WN . . 06 04 . . ANSI - WN . . 33 . .	0.04	WWE.ER2.102.003	WDE.ER4.101.017	WDE.ER3.101.000	WDE.ER1.101.000	LWX.ER1.007.002
LW4.PWLN L.0825.06	4	8	25	ISO - WN . . 06 04 . . ANSI - WN . . 33 . .	0.04	WWE.ER2.102.003	WDE.ER4.101.017	WDE.ER3.101.000	WDE.ER1.101.000	LWX.ER1.007.002
LW5.PWLN R.1025.06	5	10	25	ISO - WN . . 06 04 . . ANSI - WN . . 33 . .	0.07	WWE.ER2.102.003	WDE.ER4.101.017	WDE.ER3.101.000	WDE.ER1.101.000	LWX.ER1.007.002
LW5.PWLN L.1025.06	5	10	25	ISO - WN . . 06 04 . . ANSI - WN . . 33 . .	0.07	WWE.ER2.102.003	WDE.ER4.101.017	WDE.ER3.101.000	WDE.ER1.101.000	LWX.ER1.007.002



**SVVC N 72.5°/35°**

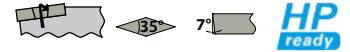
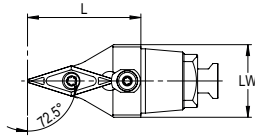
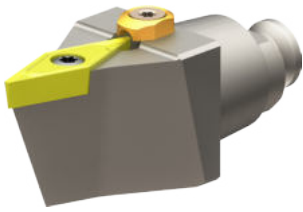

Bestell.Nr. / Order number/ Code	LW	f	L	Wendeplatte/ Insert/ Plaquette	kg				
LW3.SVVCN.0025.11	3	0	25	ISO - VC .. 11 03 .. ANSI - VC .. 22 ..	0.03	WCA.ER1.001.000	WCA.ER2.001.006 (0.9 Nm)	LWX.ER1.007.002	LW3.U00.ER1.000
LW3.SVVCN.0030.13	3	0	30	ISO - VC .. 13 03 .. ANSI - VC .. 252 ..	0.03	WCA.ER1.001.000	WCA.ER2.001.007 (0.9 Nm)	LWX.ER1.007.002	LW3.U00.ER1.000
LW4.SVVCN.0025.11	4	0	25	ISO - VC .. 11 03 .. ANSI - VC .. 22 ..	0.04	WCA.ER1.001.000	WCA.ER2.001.006 (0.9 Nm)	LWX.ER1.007.002	LW4.U00.ER1.000
LW4.SVVCN.0030.13	4	0	30	ISO - VC .. 13 03 .. ANSI - VC .. 252 ..	0.05	WCA.ER1.001.000	WCA.ER2.001.007 (0.9 Nm)	LWX.ER1.007.002	LW4.U00.ER1.000
LW4.SVVCN.0035.16	4	0	35	ISO - VC .. 16 04 .. ANSI - VC .. 33 ..	0.06	WCB.ER1.001.000	WCB.ER2.001.009 (3.0 Nm)	LWX.ER1.007.002	LW4.U00.ER1.000
LW5.SVVCN.0035.16	5	0	35	ISO - VC .. 16 04 .. ANSI - VC .. 33 ..	0.07	WCB.ER1.001.000	WCB.ER2.001.009 (3.0 Nm)	LWX.ER1.007.002	LW4.U00.ER1.000

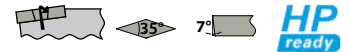
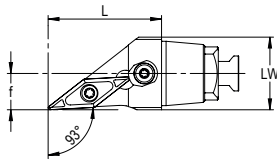
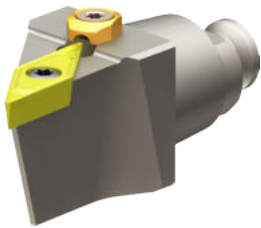

**SVJC R/L 93°/35°**



Bestell.Nr. / Order number/ Code	LW	f	L	Wendeplatte/ Insert/ Plaquette	kg				
LW3.SVJCR.0625.11	3	6	25	ISO - VC .. 11 03 .. ANSI - VC .. 22 ..	0.03	WCA.ER1.001.000	WCA.ER2.001.006 (0.9 Nm)	LWX.ER1.007.002	LW3.U00.ER1.000
LW3.SVJCL.0625.11	3	6	25	ISO - VC .. 11 03 .. ANSI - VC .. 22 ..	0.03	WCA.ER1.001.000	WCA.ER2.001.006 (0.9 Nm)	LWX.ER1.007.002	LW3.U00.ER1.000
LW3.SVJCR.0630.13	3	6	30	ISO - VC .. 13 03 .. ANSI - VC .. 252 ..	0.03	WCA.ER1.001.000	WCA.ER2.001.007 (0.9 Nm)	LWX.ER1.007.002	LW3.U00.ER1.000
LW3.SVJCL.0630.13	3	6	30	ISO - VC .. 13 03 .. ANSI - VC .. 252 ..	0.03	WCA.ER1.001.000	WCA.ER2.001.007 (0.9 Nm)	LWX.ER1.007.002	LW3.U00.ER1.000
LW4.SVJCR.0825.11	4	8	25	ISO - VC .. 11 03 .. ANSI - VC .. 22 ..	0.04	WCA.ER1.001.000	WCA.ER2.001.006 (0.9 Nm)	LWX.ER1.007.002	LW4.U00.ER1.000
LW4.SVJCL.0825.11	4	8	25	ISO - VC .. 11 03 .. ANSI - VC .. 22 ..	0.04	WCA.ER1.001.000	WCA.ER2.001.006 (0.9 Nm)	LWX.ER1.007.002	LW4.U00.ER1.000
LW4.SVJCR.0830.13	4	8	30	ISO - VC .. 13 03 .. ANSI - VC .. 252 ..	0.05	WCA.ER1.001.000	WCA.ER2.001.007 (0.9 Nm)	LWX.ER1.007.002	LW4.U00.ER1.000
LW4.SVJCL.0830.13	4	8	30	ISO - VC .. 13 03 .. ANSI - VC .. 252 ..	0.05	WCA.ER1.001.000	WCA.ER2.001.007 (0.9 Nm)	LWX.ER1.007.002	LW4.U00.ER1.000
LW4.SVJCR.0835.16	4	8	35	ISO - VC .. 16 04 .. ANSI - VC .. 33 ..	0.06	WCB.ER1.001.000	WCB.ER2.001.009 (3.0 Nm)	LWX.ER1.007.002	LW4.U00.ER1.000
LW4.SVJCL.0835.16	4	8	35	ISO - VC .. 16 04 .. ANSI - VC .. 33 ..	0.06	WCB.ER1.001.000	WCB.ER2.001.009 (3.0 Nm)	LWX.ER1.007.002	LW4.U00.ER1.000
LW5.SVJCR.1035.16	5	10	35	ISO - VC .. 16 04 .. ANSI - VC .. 33 ..	0.07	WCB.ER1.001.000	WCB.ER2.001.009 (3.0 Nm)	LWX.ER1.007.002	LW4.U00.ER1.000
LW5.SVJCL.1035.16	5	10	35	ISO - VC .. 16 04 .. ANSI - VC .. 33 ..	0.07	WCB.ER1.001.000	WCB.ER2.001.009 (3.0 Nm)	LWX.ER1.007.002	LW4.U00.ER1.000

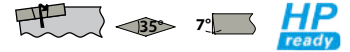
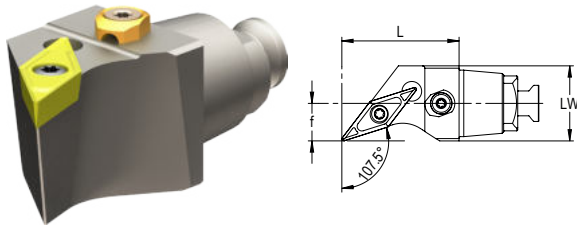



**SVHC R/L 107.5°/35°**

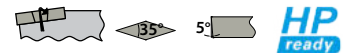
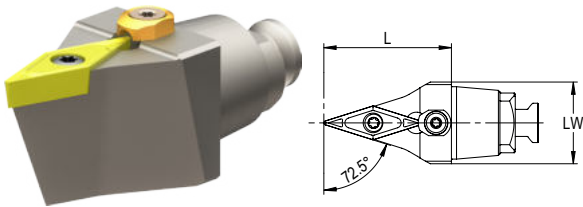

Bestell.Nr. / Order number/ Code	LW	f	L	Wendeplatte/ Insert/ Plaquette	kg				
LW3.SVHCR.0625.11	3	6	25	ISO - VC .. 11 03 .. ANSI - VC .. 22 ..	0.03	WCA.ER1.001.000	WCA.ER2.001.006 (0.9 Nm)	LWX.ER1.007.002	LW3.U00.ER1.000
LW3.SVHCL.0625.11	3	6	25	ISO - VC .. 11 03 .. ANSI - VC .. 22 ..	0.03	WCA.ER1.001.000	WCA.ER2.001.006 (0.9 Nm)	LWX.ER1.007.002	LW3.U00.ER1.000
LW4.SVHCR.0825.11	4	8	25	ISO - VC .. 11 03 .. ANSI - VC .. 22 ..	0.04	WCA.ER1.001.000	WCA.ER2.001.006 (0.9 Nm)	LWX.ER1.007.002	LW4.U00.ER1.000
LW4.SVHCL.0825.11	4	8	25	ISO - VC .. 11 03 .. ANSI - VC .. 22 ..	0.04	WCA.ER1.001.000	WCA.ER2.001.006 (0.9 Nm)	LWX.ER1.007.002	LW4.U00.ER1.000
LW5.SVHCR.1035.16	5	10	35	ISO - VC .. 16 04 .. ANSI - VC .. 33 ..	0.08	WCB.ER1.001.000	WCB.ER2.001.009 (3.0 Nm)	LWX.ER1.007.002	LW4.U00.ER1.000
LW5.SVHCL.1035.16	5	10	35	ISO - VC .. 16 04 .. ANSI - VC .. 33 ..	0.08	WCB.ER1.001.000	WCB.ER2.001.009 (3.0 Nm)	LWX.ER1.007.002	LW4.U00.ER1.000





**SVVB N 72.5°/35°**

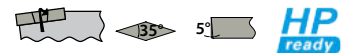
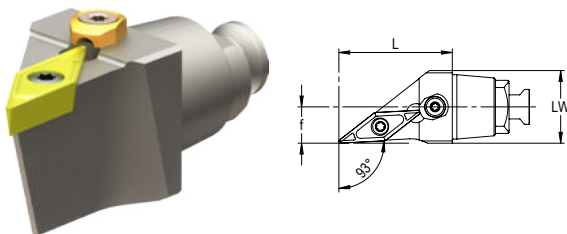

Bestell.Nr. / Order number/ Code	LW	f	L	Wendeplatte/ Insert/ Plaquette	kg				
LW3.SVVB N.0025.11	3	0	25	ISO - VB .. 11 03 .. ANSI - VB .. 22 ..	0.03	WCA.ER1.001.000	WCA.ER2.001.006 (0.9 Nm)	LWX.ER1.007.002	LW3.U00.ER1.000
LW4.SVVB N.0025.11	4	0	25	ISO - VB .. 11 03 .. ANSI - VB .. 22 ..	0.04	WCA.ER1.001.000	WCA.ER2.001.006 (0.9 Nm)	LWX.ER1.007.002	LW4.U00.ER1.000
LW5.SVVB N.0025.11	5	0	25	ISO - VB .. 11 03 .. ANSI - VB .. 22 ..	0.05	WCA.ER1.001.000	WCA.ER2.001.006 (0.9 Nm)	LWX.ER1.007.002	LW4.U00.ER1.000

**SVJB R/L 93°/35°**



Bestell.Nr. / Order number/ Code	LW	f	L	Wendeplatte/ Insert/ Plaquette	kg				
LW3.SVJBR.0625.11	3	6	25	ISO - VB .. 11 03 .. ANSI - VB .. 22 ..	0.03	WCA.ER1.001.000	WCA.ER2.001.006 (0.9 Nm)	LWX.ER1.007.002	LW3.U00.ER1.000
LW3.SVJBL.0625.11	3	6	25	ISO - VB .. 11 03 .. ANSI - VB .. 22 ..	0.03	WCA.ER1.001.000	WCA.ER2.001.006 (0.9 Nm)	LWX.ER1.007.002	LW3.U00.ER1.000
LW4.SVJBR.0825.11	4	8	25	ISO - VB .. 11 03 .. ANSI - VB .. 22 ..	0.04	WCA.ER1.001.000	WCA.ER2.001.006 (0.9 Nm)	LWX.ER1.007.002	LW4.U00.ER1.000
LW4.SVJBL.0825.11	4	8	25	ISO - VB .. 11 03 .. ANSI - VB .. 22 ..	0.04	WCA.ER1.001.000	WCA.ER2.001.006 (0.9 Nm)	LWX.ER1.007.002	LW4.U00.ER1.000
LW5.SVJBR.1025.11	5	10	25	ISO - VB .. 11 03 .. ANSI - VB .. 22 ..	0.05	WCA.ER1.001.000	WCA.ER2.001.006 (0.9 Nm)	LWX.ER1.007.002	LW4.U00.ER1.000
LW5.SVJBL.1025.11	5	10	25	ISO - VB .. 11 03 .. ANSI - VB .. 22 ..	0.05	WCA.ER1.001.000	WCA.ER2.001.006 (0.9 Nm)	LWX.ER1.007.002	LW4.U00.ER1.000

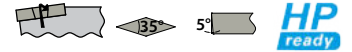
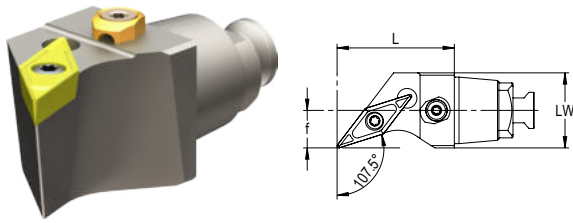





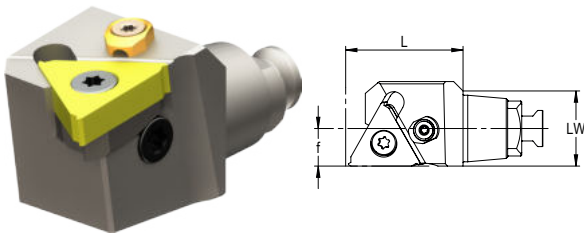

Bestell.Nr. / Order number/ Code	LW	f	L	Wendeplatte/ Insert/ Plaqueette	kg				
LW3.SVHBR.0625.11	3	6	25	ISO - VB .. 11 03 .. ANSI - VB .. 22 ..	0.03	WCA.ER1.001.000	WCA.ER2.001.006 (0.9 Nm)	LWX.ER1.007.002	LW3.U00.ER1.000
LW3.SVHBL.0625.11	3	6	25	ISO - VB .. 11 03 .. ANSI - VB .. 22 ..	0.03	WCA.ER1.001.000	WCA.ER2.001.006 (0.9 Nm)	LWX.ER1.007.002	LW3.U00.ER1.000
LW4.SVHBR.0825.11	4	8	25	ISO - VB .. 11 03 .. ANSI - VB .. 22 ..	0.04	WCA.ER1.001.000	WCA.ER2.001.006 (0.9 Nm)	LWX.ER1.007.002	LW4.U00.ER1.000
LW4.SVHBL.0825.11	4	8	25	ISO - VB .. 11 03 .. ANSI - VB .. 22 ..	0.04	WCA.ER1.001.000	WCA.ER2.001.006 (0.9 Nm)	LWX.ER1.007.002	LW4.U00.ER1.000
LW5.SVHBR.1025.11	5	10	25	ISO - VB .. 11 03 .. ANSI - VB .. 22 ..	0.06	WCA.ER1.001.000	WCA.ER2.001.006 (0.9 Nm)	LWX.ER1.007.002	LW4.U00.ER1.000
LW5.SVHBL.1025.11	5	10	25	ISO - VB .. 11 03 .. ANSI - VB .. 22 ..	0.06	WCA.ER1.001.000	WCA.ER2.001.006 (0.9 Nm)	LWX.ER1.007.002	LW4.U00.ER1.000

Aussengewinde radial

External thread radial

Filet extérieur radial



Bestell.Nr. / Order number/ Code	LW	f	L	Wendeplatte/ Insert/ Plaqueette	kg					
LW3.SER.0625.16	3	6	25	16 ER	0.04	WGB.ER1.001.000	WGB.ER2.001.012 (2.0 Nm)	WGB.ER2.102.003	WGB.ER3.001.007 (2.0 Nm)	LWX.ER1.007.002
LW3.SEL.0625.16	3	6	25	16 EL	0.04	WGB.ER1.001.000	WGB.ER2.001.012 (2.0 Nm)	WGB.ER2.101.003	WGB.ER3.001.007 (2.0 Nm)	LWX.ER1.007.002
LW4.SER.0825.16	4	8	25	16 ER	0.06	WGB.ER1.001.000	WGB.ER2.001.012 (2.0 Nm)	WGB.ER2.102.003	WGB.ER3.001.007 (2.0 Nm)	LWX.ER1.007.002
LW4.SEL.0825.16	4	8	25	16 EL	0.06	WGB.ER1.001.000	WGB.ER2.001.012 (2.0 Nm)	WGB.ER2.101.003	WGB.ER3.001.007 (2.0 Nm)	LWX.ER1.007.002
LW5.SER.1025.16	5	10	25	16 ER	0.08	WGB.ER1.001.000	WGB.ER2.001.012 (2.0 Nm)	WGB.ER2.102.003	WGB.ER3.001.007 (2.0 Nm)	LWX.ER1.007.002
LW5.SEL.1025.16	5	10	25	16 EL	0.08	WGB.ER1.001.000	WGB.ER2.001.012 (2.0 Nm)	WGB.ER2.101.003	WGB.ER3.001.007 (2.0 Nm)	LWX.ER1.007.002

## Grundhalter rund

## Round holders

## Porte-outil rond

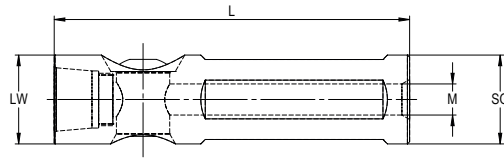

Bestell.Nr. / Order number/ Code	LW	SG	L	Coolant M	kg		
U16.LW3.K01.080	3	16	80	M8x1	0.09	LW3.ER1.012.014	LWX.ER1.008.004
U19.LW5.K01.080	5	19.05	80	M8x1	0.14	LW4.ER1.014.018	LWX.ER1.008.004
U20.LW5.K01.080	5	20	80	M8x1	0.15	LW4.ER1.014.018	LWX.ER1.008.004
U22.LW5.K01.080	5	22	80	M8x1	0.19	LW4.ER1.014.019	LWX.ER1.008.004
U25.LW5.K01.080	5	25	80	M8x1	0.26	LW4.ER1.015.023	LWX.ER1.008.004
U26.LW5.K01.080	5	25.4	80	M8x1	0.27	LW4.ER1.015.023	LWX.ER1.008.004

- für effiziente Drehbearbeitung
- mit Kühlmitteldirektanschluss
- Sonderabmasse auf Anfrage

- to turn efficiently
- with direct coolant connection
- Special dimensions on request

- pour un tournage efficace
- avec raccord direct de liquide de refroidissement
- Dimensions spéciales sur demande

## Spannzangenfutter

## Collet Chuck

## Porte-pinces

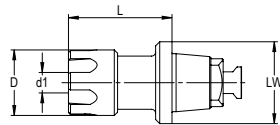

Bestell.Nr. / Order number/ Code	LW	D	L	Spannzange	d1	kg		
LW3.E11.K01.026	3	16	26	ER11	0.5 . 7	0.03	LW3.U00.ER1.000	E11.ER1.001.012
LW5.E11.K01.026	5	16	26	ER11	0.5 . 7	0.05	LW4.U00.ER1.000	E11.ER1.001.012
LW5.E16.K01.035	5	22	35	ER16	0.5 . 10	0.07	LW4.U00.ER1.000	E16.ER1.001.018

## Halter für Schneideinsätze

## Boring bar holder

## Porte-outils d'alésage

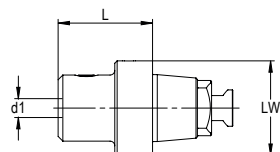

Bestell.Nr. / Order number/ Code	LW	L1	d1	kg	
LW5.D04.K01.020	5	20	4	0.05	LW4.U00.ER1.000 A25.BG4.007.020 ISO 4026 . M4 x 5
LW5.D07.K01.025	5	25	7	0.06	LW4.U00.ER1.000 A25.BG4.007.020 ISO 4026 . M4 x 5

## Schneideinsätze

## Boring bars

## Barres d'alésage

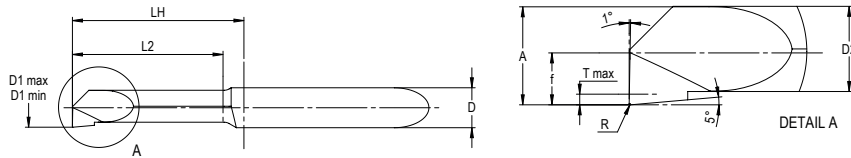
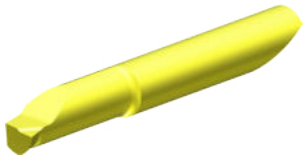

Bestell.Nr. / Order number/ Code	D	L2	D min	D max	R	A	D2	f	LH	T max
255.004.003.013	4.0	1.2	0.3	0.7	-	0.25	0.15	0.15	11.0	0.03
255.004.006.013	4.0	2.5	0.6	1.1	-	0.55	0.46	0.30	11.0	0.05
255.004.010.013	4.0	4.0	1.0	2.3	0.05	0.95	0.65	0.50	11.0	0.1
255.004.022.013	4.0	6.0	2.2	3.3	0.05	2.00	1.55	1.10	11.0	0.2
255.004.032.013	4.0	10.2	3.2	4.3	0.05	3.00	2.55	1.60	11.0	0.2
255.004.039.018	4.0	15.2	3.9	(7.1)	0.05	3.70	3.45	1.95	16.0	0.3
255.007.052.023	7.0	20.3	5.2	6.3	0.05	5.00	4.25	2.60	21.0	0.5
255.007.062.023	7.0	20.3	6.2	7.3	0.05	6.00	5.25	3.10	21.0	0.5
255.007.069.028	7.0	25.4	6.9	12.1	0.20	6.70	6.25	3.45	26.0	0.5

## Schneidplatten

## Inserts

## Plaquettes

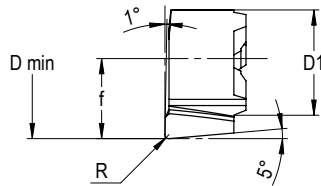

Bestell.Nr. / Order number/ Code	D min	Dd max	R	f	D1	Tmax	Code
283.007.069.004	6.9	8.1	0.2	3.45	4.8	1.0	D07
283.007.079.004	7.9	9.1	0.2	3.95	4.8	1.0	D07
283.007.089.004	8.9	10.1	0.2	4.45	4.8	1.0	D07
283.010.099.004	9.9	12.1	0.2	4.95	7	1.0	D10
283.010.119.004	11.9	14.1	0.2	5.95	7	1.0	D10
283.010.139.004	13.9	19.1	0.2	6.95	7	1.0	D10

## Adapter für Schneidplatten

## Adapter for inserts

## Adapter pour les plaquettes

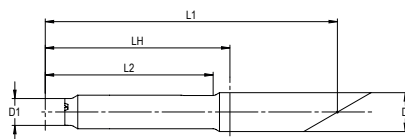



Bestell.Nr. / Order number/ Code	ØD h6	L2	Ø d1	L1	LH	Schraube/ screw	Torx	Code
282.007.007.033	7.0	30	4.8	56	31	M2x7.5 (900.254.020.007)	T7	D07
282.007.010.038	7.0	35	7.0	61	36	M3x9.0 (900.254.030.009)	T9	D10

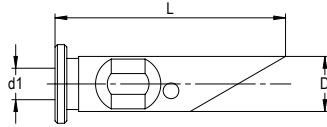

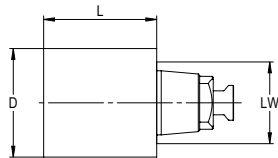

Code/ Bestell-Nr. / Order number	D	d1	L
224.007.004.030	7	4	(30)



Bestell.Nr. / Order number / Code	LW	D	L	kg	
LW3.Ro1.023.037	3	23	37	0.13	LW3.U00.ER1.000
LW4.Ro1.030.043	4	30	43	0.25	LW4.U00.ER1.000
LW5.Ro1.030.043	5	30	43	0.25	LW4.U00.ER1.000

# SWISS-MICRO QUICK-CHANGE SYSTEM

- Manipulation facile
- Changement d'outil rapide
- Pré-reglage précis
- Interface rigide

## **Système innovant de changement rapide ST-Micro - pour les outils statiques**

Développé pour les décolleteuses et les tours automatiques multi-broches. La réduction du temps non productif a été le principal objectif du processus de développement de cet outil. Le changement des plaquettes n'est souvent possible que sous condition, en raison de la conception des machines. Dans la plupart des cas, les supports de base complets doivent être retirés. Cela prend beaucoup de temps et entraîne des temps d'arrêt importants. C'est désormais une chose du passé. Le système ST-Micro offre des solutions pour l'usinage interne et externe. La gamme comprend des supports carrés de dimensions 12x12 et 16x16 ainsi que des supports ronds de Ø20, 22 et 25 mm et des dimensions en pouces de 19,05 et 25,4 mm. La précision, la stabilité et la facilité de maniabilité ne laissent rien à désirer.

- Les supports de base avec raccordement pour l'arrosage permettent une utilisation dans n'importe quelle position possible dans la machine.
- L'utilisation simple d'une seule main permet un changement sûr et facile des adaptateurs de plaquettes.
- Tous les adaptateurs peuvent être pré-réglés et mesurés en dehors de la machine.
- Le changement d'outil s'effectue en quelques secondes.
- Les temps de préparation et de non-productivité sont réduits au minimum et la productivité de votre machine est augmentée au maximum.
- La conception de l'interface garantit un positionnement exactpositionnement exact dans la plage des  $\mu$ .

# SWISS-MICRO QUICK-CHANGE SYSTEM

- Einfaches Handling
- Schnelle Werkzeugwechsel
- Präzise Voreinstellung
- Stabile Schnittstelle

## Innovatives Schnellwechselsystem ST-Micro – für statische Werkzeuge

Entwickelt für Langdrehmaschinen und Mehrspindeldrehautomaten.

Reduktion von Nebenzeiten stand bei Entwicklungsprozess von diesem Werkzeug im Vordergrund. Der Wechsel der Wendschneidplatten ist oft durch die Bauweise der Maschinen nur bedingt möglich. Meist müssen die kompletten Grundhalter ausgebaut werden. Dies ist sehr zeitaufwändig und führt zu hohen Stillstandszeiten. Das gehört jetzt der Vergangenheit an.

Das ST-Micro System, bietet Lösungen für die Innen- und Außenbearbeitung. Das Sortiment umfasst Vierkantaufnahmen der Baugrößen 12x12 / 16x16 / 20x20 / 1/2"x1/2" / 5/8"x 5/8" sowie Rundaufnahmen Ø20, 22 und 25mm sowie die Inch Dimensionen 19.05 und 25.4 mm. Präzision, Stabilität und Bedienerfreundlichkeit lassen keine Wünsche offen.

- Grundhalter mit integriertem Kühlmittelanschluss ermöglichen den Einsatz auf jeder möglichen Position in der Maschine.
- Die einfache Einhandbedienung erlaubt einen sicheren und einfachen Wechsel der Wendschneidplattenadapter.
- Sämtliche Adapter können außerhalb der Maschine voreingestellt und vermessen werden.
- Der Werkzeugwechsel erfolgt innerhalb weniger Sekunden.
- Die Rüst- und Nebenzeiten werden auf ein Minimum reduziert und die Produktivität Ihrer Maschine auf ein Maximum gesteigert.
- Die Konzeption der Schnittstelle garantiert eine exakte Lagepositionierung und Genauigkeit im einstelligen µ-Bereich.

- Easy handling
- Fast tool change
- Precise presetting
- Stable interface

## Innovative quick-change system ST-Micro - for static tools

Designed for Swiss-type machines and multi-spindle lathes.

Reduce the non-productive time was the highest priority by the developing process of this tool. To change the indexable inserts is often limited by the design of the machines. In most cases, the complete basic holder must be removed. This is very time consuming and leads to high downtime. This is now a thing of the past.

The ST-Micro system offers solutions for internal and external machining. The assortment includes square holders of the sizes 12x12 / 16x16 / 20x20 / 1/2"x1/2" / 5/8"x 5/8" as well as round shanks Ø20, 22 and 25mm as well as the inch dimensions 19.05 and 25.4 mm. Precision, stability and user-friendliness is guaranteed.

- Basic holder with integrated coolant connection can be used at every possible position in the machine.
- The simple one-hand operation allows a safe and secure easy change of indexable insert adapter.
- All adapters can be adjusted and preset outside the machine.
- The tool change takes place within a few seconds.
- Setup times are kept to a minimum - productivity of your machine to a maximum
- The design of the interface guarantees an exact location positioning and accuracy in the single-digit µ range.

**SWISS+TOOLS**<sup>®</sup>  
**SCHAUBLIN**

Swiss Tool Systems AG  
Wydenstrasse 28  
CH-8575 Bürglen  
Phone +41 (0)71 634 85 20  
Fax +41 (0)71 634 85 29  
[www.swisstools.org](http://www.swisstools.org)